

REFORM 52 RECESSED SPOT

Installation Manual



1



Attention

Before any maintenance switch off the main power.

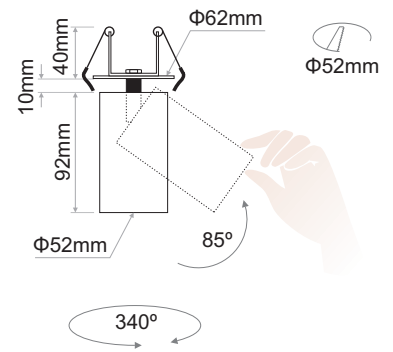
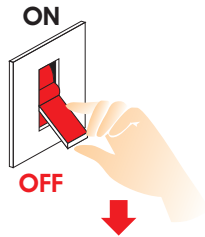

2

2.1

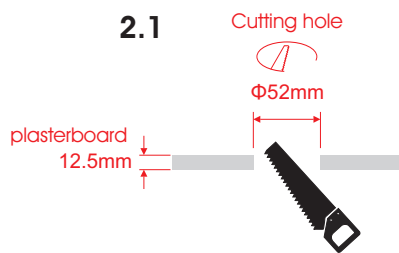

2.2

Connect the LED Driver at 230VAC.

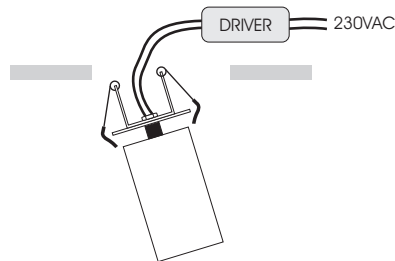

3

3.1

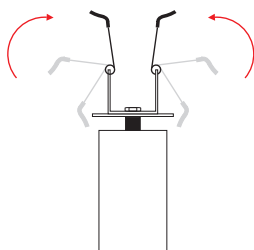

3.2

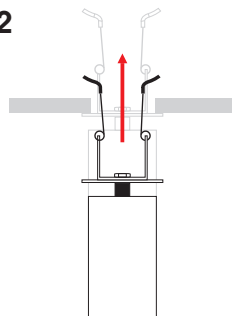

3.3

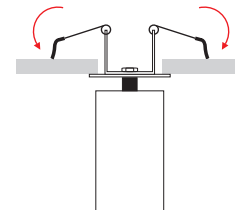

4

